

EMIL ROSI chair with armrests

SERENER

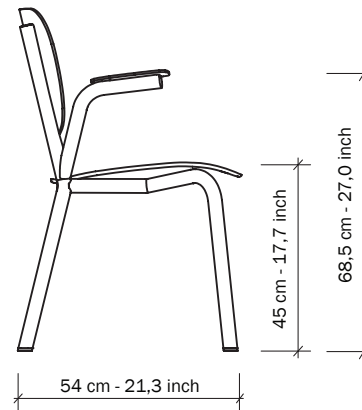
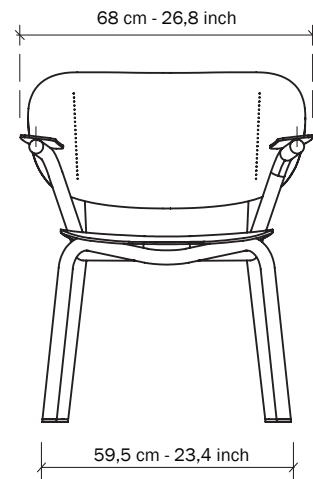
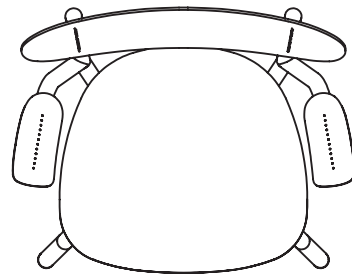

SPECIFICATIONS

Back and armrests:

Saddle leather in black or cognac with army green stitching or in natural with yellow stitching.

Oak seat:

Core: Layered beech wood.

Top and bottom: Oak veneer, transparent or black lacquered.

Leather seat:

Core: Layered beech wood.

Top: black leather

Bottom: black cotton

Frame:

Aluminium, powder coated in black or white.

Feet:

Plastic, in dark or light brown.

Weight:

5,3 kg - 11,7 lb.

3D-FILES OR HR-IMAGES

Check: www.functionals.eu/downloads



Black | Black | Black oak



Cognac | White | Oak



Natural | White | Oak



Black | Black | Black leather



Cognac | White | Black leather



Natural | White | Black leather

FUNCTIONALS

Functionals

Edisonstraat 5

NL-5051 DS Goirle

tel. +31 (0)13 530 03 89

info@functionals.eu

www.functionals.eu

EMIL ROSI chair with armrests

SERENER

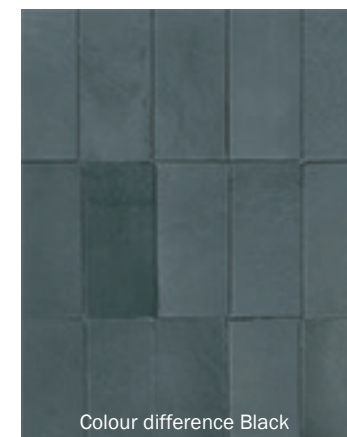
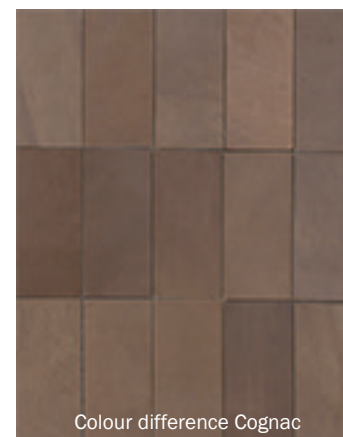
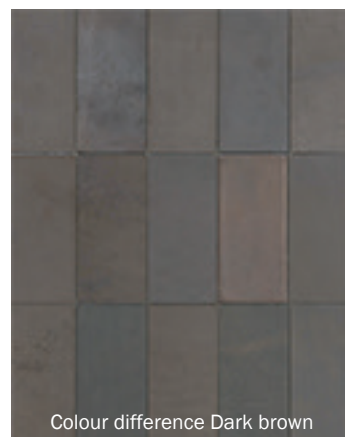
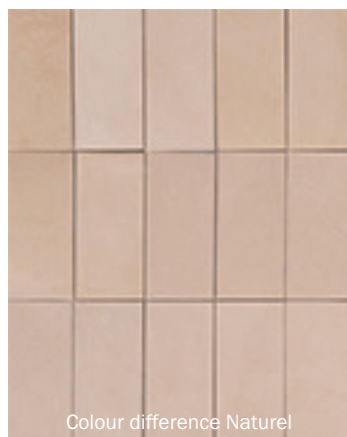
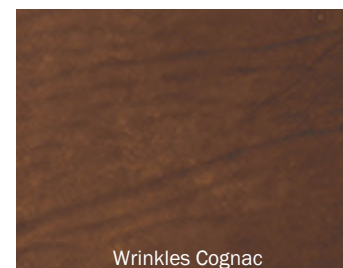
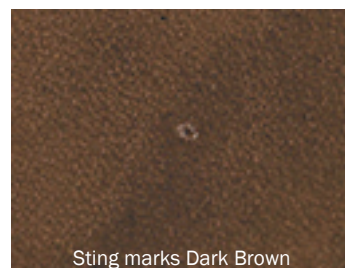
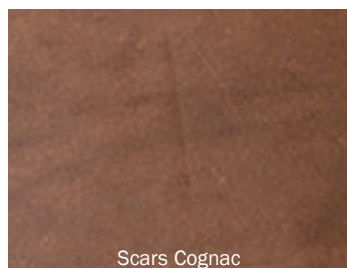
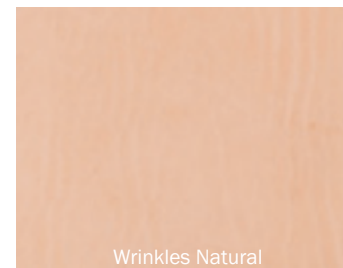
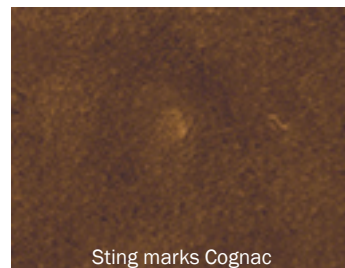
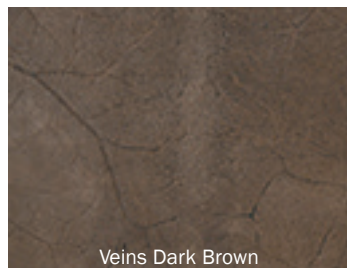

PERFECT IMPERFECTIONS

Leather is a natural product so expect to see some irregularities in its appearance. The quality is in no way diminished by such variations. Functionals has a very strict selection process, we only choose the best skins.

What we call "perfect imperfections" are most visible in lighter colors like natural and cognac. See some examples of common irregularities on this page.

FUNCTIONALS

Functionals
Edisonstraat 5
NL-5051 DS Goirle
tel. +31 (0)13 530 03 89
info@functionals.eu
www.functionals.eu

